

Installation instruction

In order to make the refrigerator work well, please obey below installation steps.

Attentions before installation







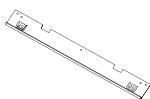
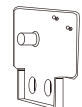
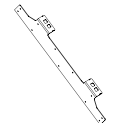

Installation position

Please keep the refrigerator away from direct sunshine and heating appliances such as stove top, over and dishwashers.

Power supply

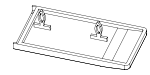
- Make sure the power plug can be easily pulled in and out when installing the refrigerator.
- The power plug should be inserted into a special socket to avoid the unexpected power off of refrigerator. Do not use extension cord or porous adapter.
- To understand the requirement for power supply by referring to the nameplate in left side of refrigerator.
- The refrigerator should be correctly grounded.

Installation parts list

1. front top plate	2. hinge plate	3. mounting plate	4. bottom fixed plate
			
1 pcs	4 pcs	2 (already installed 2)	4 pcs
5. sealing strip	6. screw cap	7. fixed small plate	8. sunk head screw
			
1 pcs	2 pcs	1 pcs	A 30 pcs
9. pan head screw	10. M6 screw	11. M6 screw cap	
			
B 6 pcs	C 10 pcs (already installed 8)	D 10 pcs (already installed 8)	

Basic size

cabinet size(mm)		Product size (mm)	
Net empty width	556 ± 2	Width	540
Net empty depth	≥ 560 (recommend 600)	Depth	555
Net empty height	1952 ± 3	Height	1940

Installation Location

You must follow the instructions below:

- The kitchen floor and the bottom of the product must be at the same level. Otherwise, problems may occur with the product's air suction.
- In order to ensure ventilation, the minimum distance between the refrigerator and the back of the cabinet must be 4 cm.
- There must be no objects preventing the installation of the product on the back and sidewalls of the product's installation location.
- The power socket must be at the correct location.
- The dimensions of the furniture located where the product will be installed must strictly adhere to the dimensions given in the manual.
- Do not install the product with the fridge and the freezer right next to each other. Otherwise, condensation and damage may occur inside the product.
- The flatness of the floor where the product will be installed must be checked with a bubble level.
- The installation area must not be subjected to direct sunlight and must be located away from heat sources, ovens, radiators.

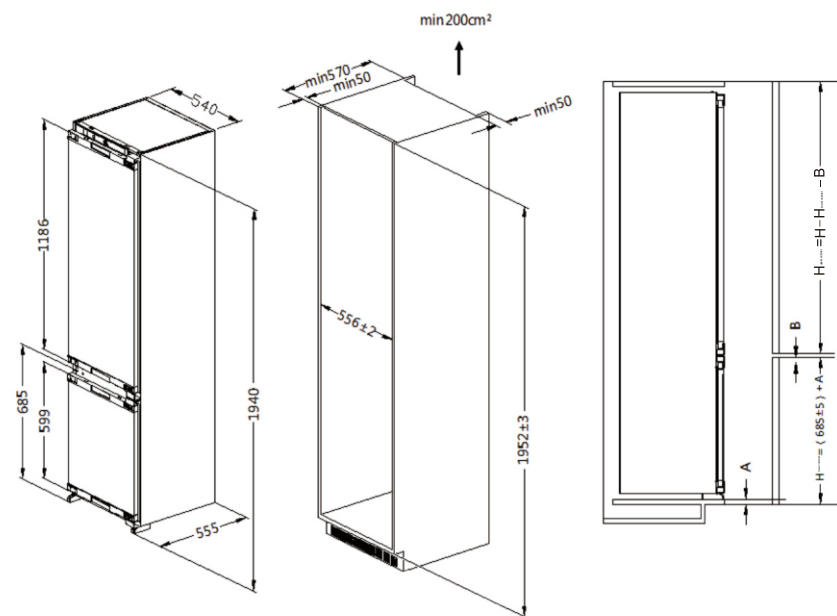

A: dimension of lower cabinet door connecting with cabinet

H: cabinet height

B: The dimension difference between upper and lower cabinet door

Preparations before installing the refrigerator

1. Confirm the direction of opening the door

The refrigerator door is opened from left side. If change to open door from right side, please install the upper and lower hinge on left side after reversing the hinges. The reversing direction is shown as arrow in the diagram. I nstall the hinge fixing plate, remove the small fixing plate in left side, then install the small fixing plate in right side after changing the direction of opening the door.

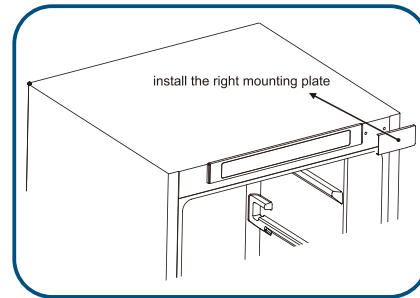
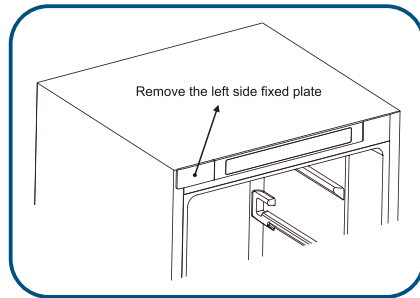
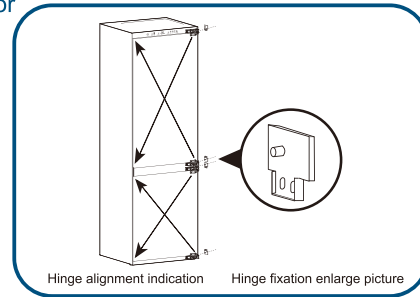

2. Install the front top plate

Fix the front top plate in front top of refrigerator with screws.

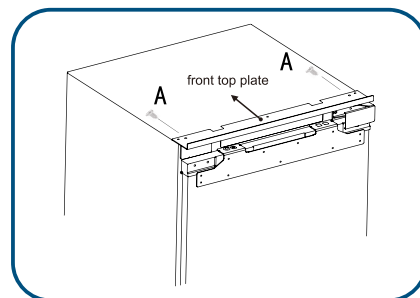

The steps to put the refrigerator inside cabinet

1. Pass the power cord through the hole on the back of the cabinet. If the power socket is inside cabinet, firstly plug the power plug into socket, then put the refrigerator inside cabinet
2. Move the refrigerator into cabinet, adjust the refrigerator position in fore-and-aft direction to ensure the front of hinge fixing plate is leveled with cabinet.



Do not squeeze the power cord. A broken power cord may lead to fire disaster.

3. Tuck the sealing strip into the gap between refrigerator and cabinet.

4. Fix the side of hinges with 2 screws (one screw to fix the first hinge, the other screw to fix the fourth hinge), after installing the cabinet door, insert other screws into the screw holes on the hinge, then tighten the screws.

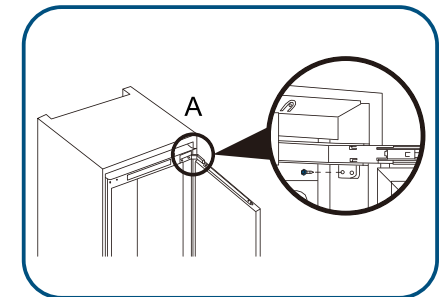

5. Fix the lower bottom feet to cabinet with screws.

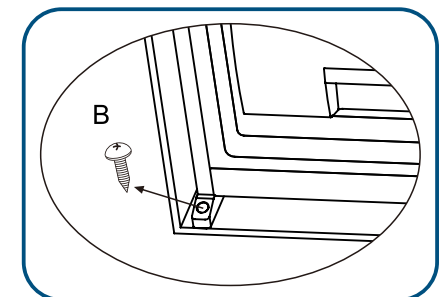

The steps to install the upper cabinet door

1. Measure the distance between upper mounting plate of refrigerator compartment door and top/left of cabinet and record the position.

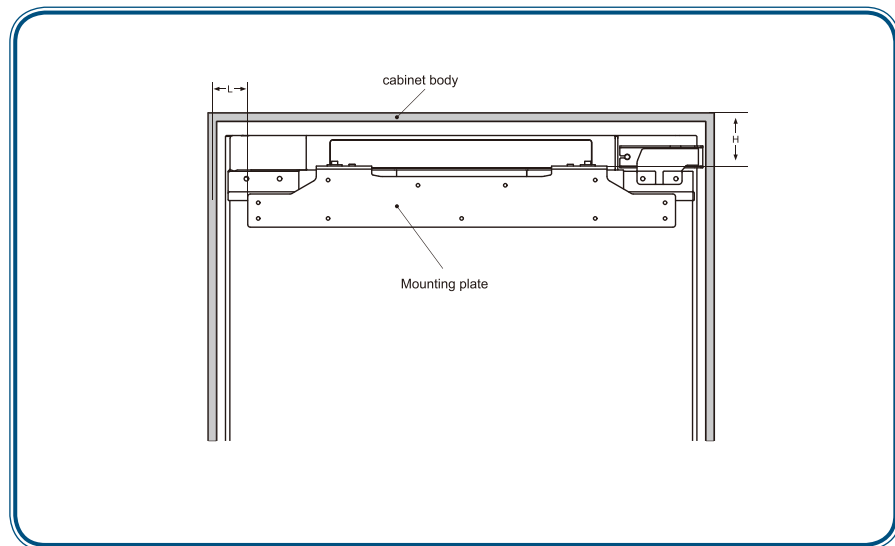

2. Loosen cap screws, then remove the mounting plate.

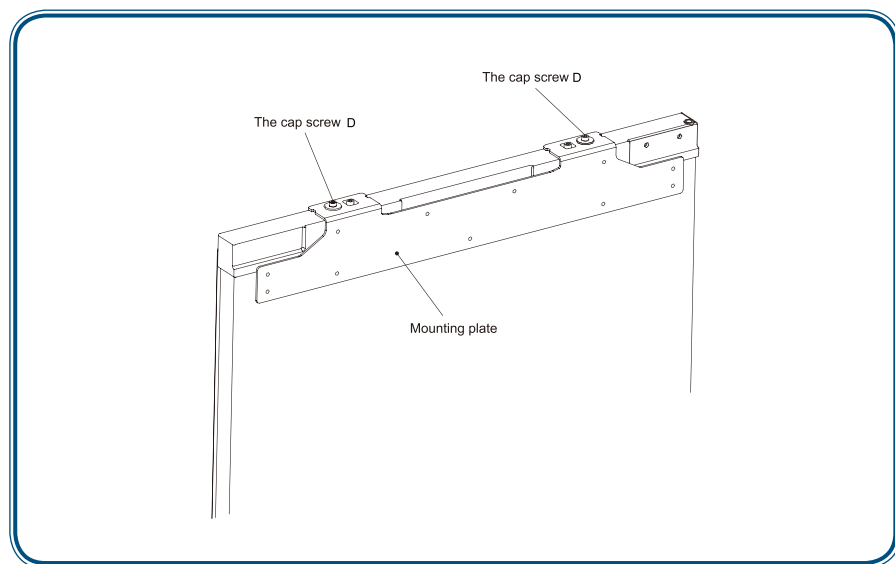

3. Measure and confirm the position to fix the mounting plate on cabinet door, then fix the mounting plate to cabinet door with screws.

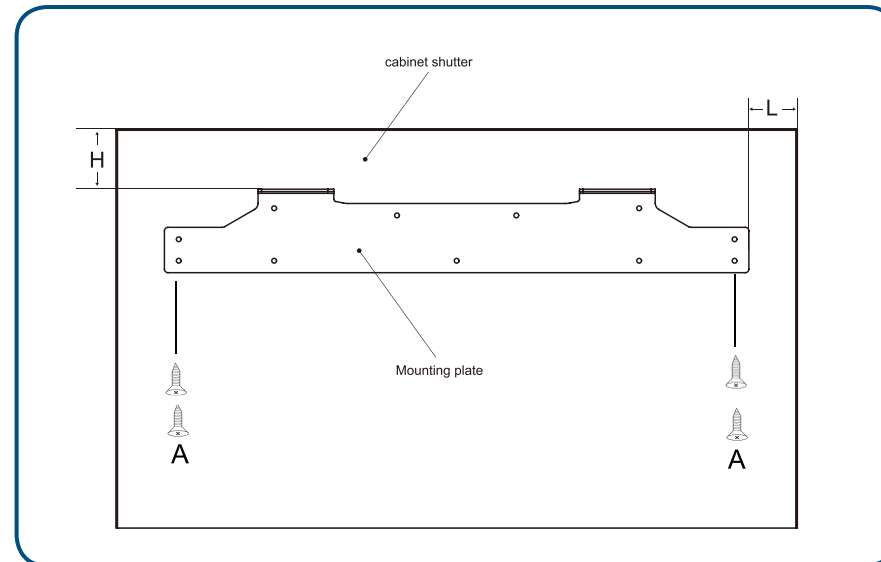

4. Fix the cabinet door to refrigerator compartment door with mounting plate, then tighten the screws (please do not overtighten the screws because the screws need to be loosened later)

5. Fix the refrigerator door to cabinet door with lower mounting plate.

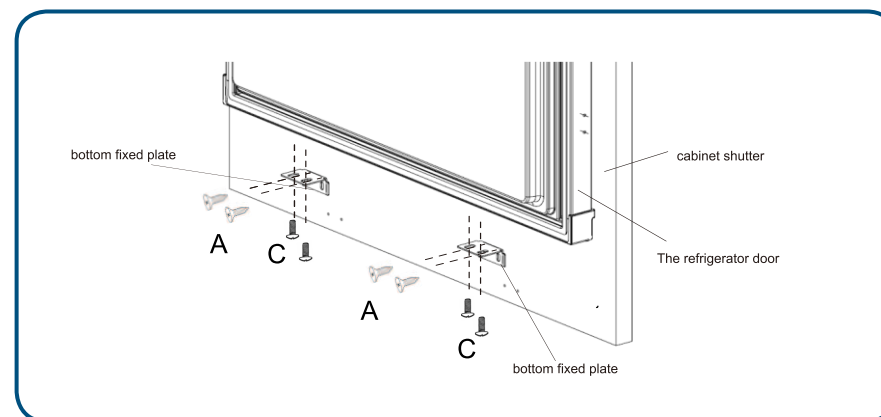

6. The procedure of installing the cabinet door to freezer compartment door is the same with the procedure of installing the cabinet door to refrigerator compartment door.

The steps to adjust the refrigerator cabinet door

Steps to adjust the upper end of refrigerator cabinet door

1. Adjustment of cabinet door in upward and downward direction

Adjustment in upward direction: Firstly adjust the cap screw D1 upwards, then adjust the cap screw D2 upwards.

Adjustment in downward direction: Firstly adjust the cap screw D2 downwards, then fix the cap screw D1.

2. Adjustment of cabinet door in leftward and downward/fore-and-aft direction

Adjustment in leftward and downward direction: Loosen cap screw D1, move the mounting plate to right position, then fix cap screw D2.

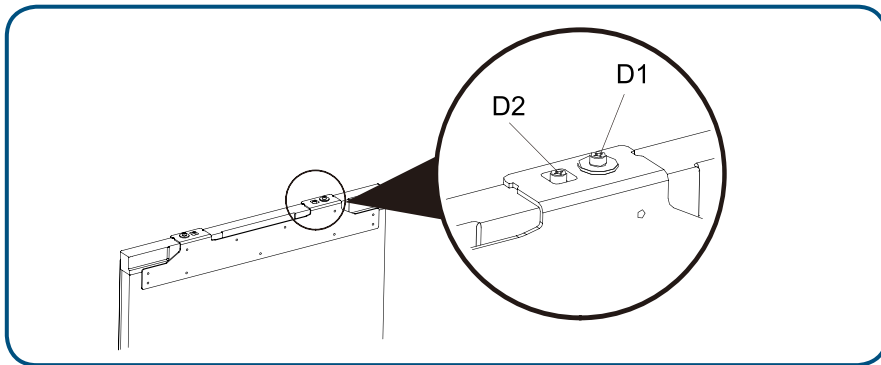

Steps to adjust the lower end of refrigerator cabinet door

1. Loosen the screws slightly, then adjust the depth (Z) and tighten the screw.
2. After adjusting the horizontal position of refrigerator cabinet door, fix the lower fixing plate to refrigerator door with screws.

