

SONY®

Television

Справочник

RU

Довідковий посібник

UA

BRAVIA

KD-65XD7505 / 55XD7005 / 49XD7005

Table of Contents

ВАЖНОЕ ПРИМЕЧАНИЕ	3
ВАЖЛИВА ПРИМІТКА	3
ЕСКЕРТУ	3
Safety information	3
Precautions	6
Parts and Controls	8
Controls and Indicators	8
Using Remote Control	9
Remote Control Parts Description	9
Connection Diagram	11
Installing the TV to the Wall	13
Troubleshooting	14
Troubles and Solutions	14
Specifications	15

Introduction

Thank you for choosing this Sony product. Before operating the TV, please read this manual thoroughly and retain it for future reference.

Note

- Before operating the TV, please read the "Safety Information" (page 3).
- Images and illustrations used in Setup Guide and this manual are for reference only and may differ from the actual product.

Location of the Setup Guide

Setup Guide is placed on top of the cushion inside the TV carton.

Help Guide

Help Guide explains the information on how to use the TV's features. To display Help Guide on the TV, press **HELP** on the remote control and select [Help Guide].

Location of the identification label

Labels for the TV Model No., Production Date (year/month) and Power Supply rating are located on the rear of the TV or package.

Дата изготовления указана на изделии и упаковке на этикетке со штрих-кодом в следующем формате: YYYY/MM, где YYYY - год изготовления, MM - месяц.

Дата виготовлення зазначена на виробі та упаковці на етикетці зі штрих-кодом у наступному форматі: YYYY/MM, де YYYY - рік виготовлення, MM - місяць.

Өндіруші: Сони Корпорейшн

Өндіруші мекенжайы: 1-7-1 Конан, Минато-ку, Токио 108-0075, Жапония

Словакияда және Малайзияда жасалған

Өндіруші ел өнімде және қорапта көрсетілген.



Кеден одағы жеріндегі шетелден әкелуші «Сони Электроникс» АҚ Ресей, 123103, Мәскеу, Карамышевский өтпе көшесі.6

Қазақстан жеріндегі тұтынушылардың шағым-талаптарын қабылдауға уәкілетті ұйым

«Сони Электроникс» АҚ Қазақстандағы Өкілдігі, 050010, Қазақстан Республикасы, Алматы қ., Достық даңғылы, 117/7 үй

WARNING

TO PREVENT THE
SPREAD OF FIRE, KEEP
CANDLES OR OTHER OPEN
FLAMES AWAY FROM THIS
PRODUCT AT ALL TIMES.



Для покупателей в Беларуси и России

Устройство KD-65XD7505, KD-55XD7005, KD-49XD7005 предназначено только для использования в помещениях.

Информация для покупателей в Украине

Уполномоченный представитель в Украине по вопросам соответствия требованиям технических регламентов:
ООО "Сони Украина", ул. Ильинская, 8, г. Киев, 04070, Украина.



Оборудование отвечает требованиям:

- Технического регламента ограничения использования некоторых опасных веществ в электрическом и электронном оборудовании (постановление КМУ от 03.12.2008 № 1057);
- Технического регламента по электромагнитной совместимости оборудования (постановление КМУ от 29.07.2009 № 785);
- Технического регламента безопасности низковольтного электрического оборудования (постановление КМУ от 29.10.2009 № 1149).

Производитель Сони Корпорейшн этим декларирует, что телевизоры моделей KD-65XD7505, KD-55XD7005, KD-49XD7005 отвечают требованиям и другим применимым положениям Технического регламента радиооборудования и телекоммуникационного конечного (терминального) оборудования. Получить декларацию соответствия можно по адресу ООО "Сони Украина", ул. Ильинская, 8, г. Киев, 04070, Украина, e-mail info@sony.ua.

ВАЖНОЕ ПРИМЕЧАНИЕ

Название продукта: Телевизор

Производитель: Сони Корпорейшн, 1-7-1 Конан, Минато-ку, Токио, 108-0075, Япония.
Сделано в Словакии и Малайзии
Страна производства указана на изделеии и упаковке.



Импортер на территории стран Таможенного союза: АО «Сони Электроникс», Россия, 123103, Москва, Карамышевский проезд, 6

Организация, уполномоченная принимать претензии от потребителей на территории Казахстана
АО «Сони Электроникс»
Представительство в Казахстане,
050010, Республика Казахстан, г. Алматы, пр. Достык, дом 117/7

ВАЖЛИВА ПРИМІТКА

Назва виробу: Телевізор

Обладнання відповідає вимогам:

- Технічного регламенту обмеження використання деяких небезпечних речовин в електричному та електронному обладнанні (постанова КМУ від 03.12.2008 № 1057);
- Технічного регламенту з електромагнітної сумісності обладнання (постанова КМУ від 29.07.2009 № 785);
- Технічного регламенту безпеки низьковольтного електричного обладнання (постанова КМУ від 29.10.2009 № 1149).

Виробник Сони Корпорейшн цим оголошує, що телевізори моделей KD-65XD7505, KD-55XD7005, KD-49XD7005 відповідають вимогам та іншим застосовним положенням Технічного регламенту радіообладнання і телекомунікаційного кінцевого (термінального) обладнання. Отримати декларацію відповідності можна за адресою ТОВ «Сони Україна», вул. Іллінська, 8, м. Київ, 04070, Україна, e-mail info@sony.ua.

Виробник: Сони Корпорейшн, 1-7-1 Конан, Минато-ку, Токио 108-0075, Японія.

Вироблено на підприємствах в Словаччині та Малайзії.
Країна виробництва зазначається на виробі та його пакуванні.
Уповноважений представник в Україні з питань відповідності вимогам технічних регламентів:

ТОВ «Сони Україна», вул. Іллінська, 8, м. Київ, 04070, Україна.

ЕСКЕРТУ

Өнім атауы: Телевизор

Safety information

WARNING

Batteries must not be exposed to excessive heat such as sunshine, fire or the like.

Never place a television set in an unstable location. A television set may fall, causing serious personal injury or death. Many injuries, particularly to children, can be avoided by taking simple precautions such as:

- Using cabinets or stands recommended by the manufacturer of the television set.
- Only using furniture that can safely support the television set.
- Ensuring the television set is not overhanging the edge of the supporting furniture.
- Not placing the television set on tall furniture (for example, cupboards or bookcases) without anchoring both the furniture and the television set to a suitable support.
- Not placing the television set on cloth or other materials that may be located between the television set and supporting furniture.
- Educating children about the dangers of climbing on furniture to reach the television set or its controls.

If your existing television set is being retained and relocated, the same considerations as above should be applied.

Installation/Set-up

Install and use the TV set in accordance with the instructions below in order to avoid any risk of fire, electric shock or damage and/or injuries.

Installation

- The TV set should be installed near an easily accessible mains socket.
- Place the TV on a stable, level surface to prevent it from falling over and causing personal injury or property damage.
- Install the TV where it cannot be pulled, pushed, or knocked over.
- Only qualified service personnel should carry out wall-mount installations.
- For safety reasons, it is strongly recommended that you use Sony accessories, including: Wall-Mount Bracket – SU-WL450
- Be sure to use the screws supplied with the Wall-Mount Bracket when attaching the Wall-Mount Bracket to the TV set. The supplied screws are designed as indicated by illustration when measured from the attaching surface of the Wall-Mount Bracket. The diameter and length of the screws differ depending on the Wall-Mount Bracket model. Use of screws other than those supplied may result in internal damage to the TV set or cause it to fall, etc.

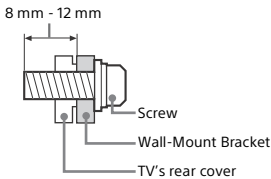

Transporting

- Before transporting the TV set, disconnect all cables.
- Two or three people are needed to transport a large TV set.
- When transporting the TV set by hand, hold it as shown below. Do not put stress on the LCD panel and the frame around the screen.

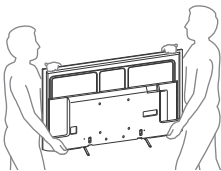

- When transporting the TV set, do not subject it to jolts or excessive vibration.
- When transporting the TV set for repairs or when moving, pack it using the original carton and packing material.

Topple prevention

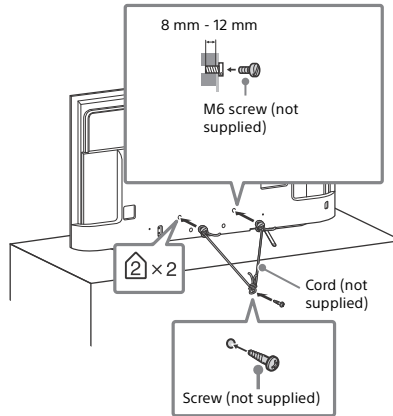

Ventilation

- Never cover the ventilation holes or insert anything in the cabinet.
- Leave space around the TV set as shown below.
- It is strongly recommended that you use a Sony Wall-Mount Bracket in order to provide adequate air circulation.

Installed on the wall

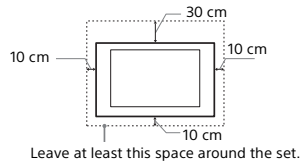

Installed with stand

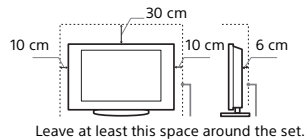

- To ensure proper ventilation and prevent the collection of dirt or dust:
 - Do not lay the TV set flat, install upside down, backwards, or sideways.
 - Do not place the TV set on a shelf, rug, bed or in a closet.
 - Do not cover the TV set with a cloth, such as curtains, or items such as newspapers, etc.
 - Do not install the TV set as shown below.

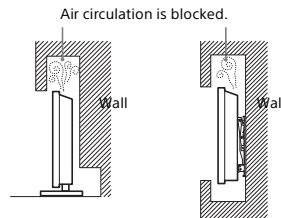

Mains lead

Handle the mains lead and socket as follows in order to avoid any risk of fire, electric shock or damage and/or injuries:

- Use only mains leads supplied by Sony, not other suppliers.
- Insert the plug fully into the mains socket.
- Operate the TV set on a 220 V - 240 V AC supply only.
- When wiring cables, be sure to unplug the mains lead for your safety and take care not to catch your feet on the cables.
- Disconnect the mains lead from the mains socket before working on or moving the TV set.
- Keep the mains lead away from heat sources.
- Unplug the mains plug and clean it regularly. If the plug is covered with dust and it picks up moisture, its insulation may deteriorate, which could result in a fire.

Note

- Do not use the supplied mains lead on any other equipment.
- Do not pinch, bend, or twist the mains lead excessively. The core conductors may be exposed or broken.
- Do not modify the mains lead.
- Do not put anything heavy on the mains lead.
- Do not pull on the mains lead itself when disconnecting the mains lead.
- Do not connect too many appliances to the same mains socket.
- Do not use a poor fitting mains socket.

Prohibited Usage

Do not install/use the TV set in locations, environments or situations such as those listed below, or the TV set may malfunction and cause a fire, electric shock, damage and/or injuries.

Location:

- Outdoors (in direct sunlight), at the seashore, on a ship or other vessel, inside a vehicle, in medical institutions, unstable locations, near water, rain, moisture or smoke.
- If the TV is placed in the changing room of a public bath or hot spring, the TV may be damaged by airborne sulfur, etc.



- For best picture quality, do not expose the screen to direct illumination or sunlight.
- Avoid moving the TV from a cold area to a warm area. Sudden room temperature changes may cause moisture condensation. This may cause the TV to show poor picture and/or poor colour. Should this occur, allow moisture to evaporate completely before powering the TV on.

Environment:

- Places that are hot, humid, or excessively dusty; where insects may enter; where it might be exposed to mechanical vibration, near flammable objects (candles, etc.). The TV set shall not be exposed to dripping or splashing and no objects filled with liquids, such as vases, shall be placed on the TV.
- Do not place the TV in a humid or dusty space, or in a room with oily smoke or steam (near cooking tables or humidifiers). Fire, electric shock, or warping may result.



- Do not install the TV in places subject to extreme temperature such as in direct sunlight, near a radiator or a heating vent. The TV may overheat in such condition which can cause deformation of the enclosure and/or TV malfunction.



Situation:

- Use when your hands are wet, with the cabinet removed, or with attachments not recommended by the manufacturer. Disconnect the TV set from mains socket and aerial during lightning storms.
- Do not install the TV so that it sticks out into an open space. This may result in injury or damage from a person or object bumping into the TV.



Broken pieces:

- Do not throw anything at the TV set. The screen glass may break by the impact and cause serious injury.
- If the surface of the TV set cracks, do not touch it until you have unplugged the mains lead. Otherwise this may cause an electric shock.

When not in use

- If you will not be using the TV set for several days, the TV set should be disconnected from the mains for environmental and safety reasons.
- As the TV set is not disconnected from the mains when the TV set is just turned off, pull the plug from the mains to disconnect the TV set completely.
- Some TV sets may have features that require the TV set to be left in standby to work correctly.

For children

- Do not allow children to climb on the TV set.
- Keep small accessories out of the reach of children, so that they are not mistakenly swallowed.

If the following problems occur...

Turn off the TV set and unplug the mains lead immediately if any of the following problems occur.

Ask your dealer or Sony service centre to have it checked by qualified service personnel.

When:

- Mains lead is damaged.
- Poor fitting of mains socket.
- TV set is damaged by being dropped, hit or having something thrown at it.
- Any liquid or solid object falls through openings in the cabinet.

About LCD TV Temperature

When the LCD TV is used for an extended period, the panel surrounds become warm. You may feel hot when touching there by the hand.

Precautions

Viewing the TV

- View the TV in moderate light, as viewing the TV in poor light or during long period of time, strains your eyes.
- When using headphones, adjust the volume so as to avoid excessive levels, as hearing damage may result.

LCD Screen

- Although the LCD screen is made with high-precision technology and 99.99 % or more of the pixels are effective, black dots may appear or bright points of light (red, blue, or green) may appear constantly on the LCD screen. This is a structural property of the LCD screen and is not a malfunction.
- Do not push or scratch the front filter, or place objects on top of this TV set. The image may be uneven or the LCD screen may be damaged.
- If this TV set is used in a cold place, a smear may occur in the picture or the picture may become dark. This does not indicate a failure. These phenomena disappear as the temperature rises.
- Ghosting may occur when still pictures are displayed continuously. It may disappear after a few moments.
- The screen and cabinet get warm when this TV set is in use. This is not a malfunction.
- The LCD screen contains a small amount of liquid crystal. Follow your local ordinances and regulations for disposal.

Handling and cleaning the screen surface/cabinet of the TV set

Be sure to unplug the mains lead connected to the TV set from mains socket before cleaning.

To avoid material degradation or screen coating degradation, observe the following precautions.

- To remove dust from the screen surface/cabinet, wipe gently with a soft cloth. If dust is persistent, wipe with a soft cloth slightly moistened with a diluted mild detergent solution.
- Never spray water or detergent directly on the TV set. It may drip to the bottom of the screen or exterior parts and enter the TV set, and may cause damage to the TV set.
- Never use any type of abrasive pad, alkaline/acid cleaner, scouring powder, or volatile solvent, such as alcohol, benzene, thinner or insecticide. Using such materials or maintaining prolonged contact with rubber or vinyl materials may result in damage to the screen surface and cabinet material.
- Do not touch the TV if your hand is covered in any chemical substance such as hand cream or sunblock.
- Periodic vacuuming of the ventilation openings is recommended to ensure to proper ventilation.
- When adjusting the angle of the TV set, move it slowly so as to prevent the TV set from moving or slipping off from its table stand.



Optional Equipment

- Keep optional components or any equipment emitting electromagnetic radiation away from the TV set. Otherwise picture distortion and/or noisy sound may occur.
- This equipment has been tested and found to comply with the limits set out in the EMC Directive using a connection signal cable shorter than 3 meters.

Recommendation of F-type plug

Projection of the inner wire from the connection part must be less than 1.5 mm.

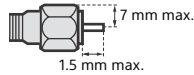

(Reference drawing of the F-type plug)

Wireless Function of the unit

- Do not operate this unit near medical equipment (pacemaker, etc.), as this may result in the malfunction of the medical equipment.
- Although this unit transmits/receives scrambled signals, be careful of unauthorised interception. We cannot be responsible for any trouble as a result.

Caution about handling the remote control

- Observe the correct polarity when inserting batteries.
- Do not use different types of batteries together or mix old and new batteries.
- Dispose of batteries in an environmentally friendly way. Certain region may regulate the disposal of batteries. Please consult your local authority.
- Handle the remote control with care. Do not drop or step on it, or spill liquid of any kind onto it.
- Do not place the remote control in a location near a heat source, a place subject to direct sunlight, or a damp room.

Утилизация телевизора



Утилизация отслужившего электрического и электронного оборудования (директива применяется в странах Евросоюза и других европейских странах, где действуют системы раздельного сбора отходов)



Утилизация использованных элементов питания (применяется в странах Евросоюза и других европейских странах, где действуют системы раздельного сбора отходов)

Утилізація телевізора



Утилізація старого електричного та електронного обладнання (застосовується в Європейському союзі та інших європейських країнах із системами роздільного збирання сміття)



Переробка використаних елементів живлення (директива діє у межах країн Європейського Союзу та інших країн Європи зі системами роздільного збору відходів)

Теледидар құрылғысын лақтыру



Қызмет мерзімі біткен электр және электрондық жабдықты залалсыз жою (бағыттама қалдықтарды бөлек жинау жүйелері жұмыс істейтін Еуроодақ және басқа еуропа елдерінде қолданылады)



Құрылғыдағы немесе оның орамындағы бұл белгі бұл құрылғыны басқа тұрмыстық қалдықтармен бірге залалсыз жоюға болмайтынын білдіреді.



Пайдаланылған қоректену элементтерін залалсыз жою (қалдықтарды бөлек жинау жүйелері жұмыс істейтін Еуроодақ елдерінде және басқа еуропа елдерінде қолданылады)

Parts and Controls

Controls and Indicators

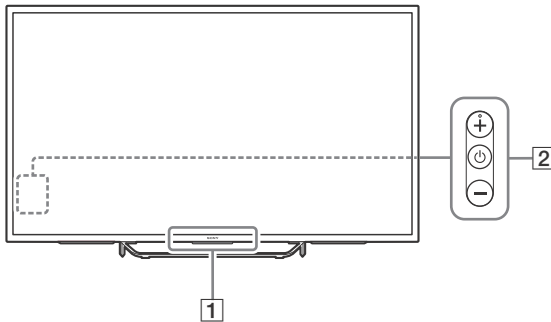

1 Remote Control sensor*¹ / Light sensor*¹ / Illumination LED

The illumination LED lights up or blinks according to the status of the TV.

- White
When turning on the TV/picture off mode/software update, etc.
- Cyan
When connecting with a mobile device wirelessly.
- Pink*²
Recording mode.
- Amber
Timer is set.

2 (Power) / + / -

When the TV is off,

Press  to power on.

When the TV is on,

Long press  to power off.

Press  repeatedly to change the function, then press + or - button to:

- Adjust the volume
- Select the channel
- Select the input source of TV

*1 Do not place anything near the sensor.

*2 Only on limited region/country/TV model.

Using Remote Control

Remote Control Parts Description

The remote control shape, location, availability and function of remote control button may vary depending on your region/country/TV model.

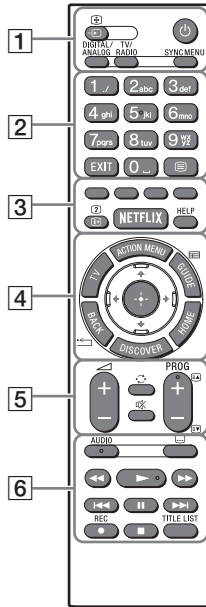

1 (Input select/Text hold)

In TV mode: Display and select the input source.

In Text mode: Hold the current page.

(TV standby)

Turn on or turn off the TV (standby mode).

DIGITAL/ANALOG

Switch between digital and analogue mode.

TV/RADIO

Switch between TV or RADIO broadcasts.

SYNC MENU

Display the BRAVIA Sync Menu.

2 Number buttons

EXIT

Return to the previous screen or exit from the menu. When an Interactive Application service is available, press to exit from the service.

(Text)

Display text information.

3 Colour buttons

Execute corresponding function at that time.

/? (Info/Text reveal)

Display information.

NETFLIX (Only on limited region/ country/TV model)

Access the "NETFLIX" online service.

HELP

Display Help Menu. Help Guide can be accessed from here.

4 ACTION MENU

Display a list of contextual functions.

TV

- Switch to a TV channel or input from other applications.
- Turn on the TV to display TV channel or input.

GUIDE/

Display the digital programme guide.

BACK/

Return to previous screen.

HOME

Display the TV Home Menu.

DISCOVER

Bring up the Content Bar to search for content.

/↓/←/→/⊕ (Item select/Enter)

5 +/- (Volume)

Adjust the volume.

(Jump)



Jump back and forth between two channels or inputs. The TV alternates between the current channel or input and the last channel or input that was selected.

(Muting)

Mute the sound. Press again to restore the sound.

PROG +/-//⏪/⏩

In TV mode: Select the channel.

In Text mode: Select the next () or previous () page.

6 AUDIO

Change the language for the programme currently being viewed.

(Subtitle setting)

Turn subtitles on or off (when the feature is available).

Operate media contents on TV and connected BRAVIA Sync-compatible device.

● REC

Record the current programme with the USB HDD recording function.

TITLE LIST

Display the Title list.

1 **AUDIO OUT***4 

- To listen to the TV's sound through the connected equipment, press **HOME**. Select [Settings] → [Sound] → [Headphone/Audio out] and then select the desired item.

2  **USB 1/2**,  **USB 3 (HDD REC)***5

- Connecting a large USB device may interfere with other connected devices beside it.
- When connecting a large USB device, connect to the USB 1 port.

3 **HDMI IN 1/2/3/4**

- If connecting a digital audio system that is compatible with Audio Return Channel (ARC) technology, use HDMI IN 3. If not, an additional connection with DIGITAL AUDIO OUT (OPTICAL) is necessary.

4  **AV 2**

- For a composite connection, use the supplied Analogue Extension Cable*5.

5  **(RF input)**,  **(Satellite input)**

- Connections for terrestrial/cable and satellite.

6  **AV 1**

- Connect with a SCART cable. When you connect an analogue decoder, the TV tuner outputs scrambled signals to the decoder, and the decoder unscrambles the signals before outputting them.

7  **CAM (Conditional Access Module)**

- Provides access to pay TV services. For details, refer to the instruction manual supplied with your CAM.
- Do not insert the smart card directly into the TV CAM slot. It must be fitted into the Conditional Access Module provided by your authorised dealer.
- CAM is not supported in some countries/ areas. Check with your authorised dealer.
- A CAM message may appear when you switch to a digital programme after using the Internet video.

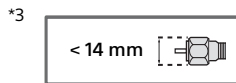
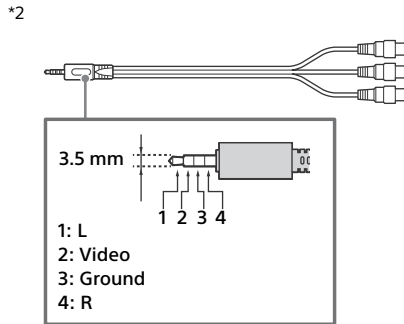
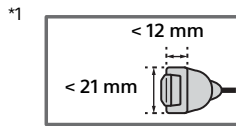

*4 Supports 3-pole stereo mini jack only.

*5 Only on limited region/country/TV model.

Installing the TV to the Wall

This TV's instruction manual only shows the steps on preparing the installation of the TV before installing to the wall.

To Customers:

For product protection and safety reasons, Sony strongly recommends that installation of your TV be performed by Sony dealers or licensed contractors. Do not attempt to install it yourself.

To Sony Dealers and Contractors:

Provide full attention to safety during the installation, periodic maintenance and examination of this product.

Sufficient expertise is required for installing this product, especially to determine the strength of the wall for withstanding the TV's weight. Be sure to entrust the attachment of this product to the wall to Sony dealers or licensed contractors and pay adequate attention to safety during the installation. Sony is not liable for any damage or injury caused by mishandling or improper installation.

Use the Wall-Mount Bracket SU-WL450 (not supplied) to install the TV to the wall.

When installing the Wall-Mount Bracket, also refer to the Operating Instructions and Installation Guide supplied with the Wall-Mount Bracket.

Note

- Be sure to store the removed screws in a safe place, keeping them away from children.



For instructions on Wall-Mount Bracket installation of your TV model, refer to the following website:
www.sony.eu/tv/wall-mount-bracket-manual

Troubleshooting

In order to keep your TV software up-to-date, it is necessary to download the latest software information via the digital broadcasting system or internet and to update the software. Select [Update Now] to start a software update. The illumination LED flashes white while the software is updating.

The following screen with [Updating...] will appear while software is updating.

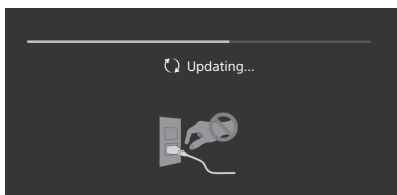

Do not unplug the mains lead during the software update. If you do, the software update may not finish completely, and it may cause a software malfunction. Software updates can take up to 30 minutes. If you do not wish to update the software automatically, press **HOME** and select [Help] → [System software update] → [Automatic software download] → [Off].

When you plug in TV, the TV may not be able to turn on for a while even if you press the power button on the remote control or the TV, because it takes time to initialize the system. Wait for about one minute, then operate it again.

When you turn on by pressing the power button on the remote control or the TV, it takes some time to turn on the illumination LED and for the remote control to be functional.

When the illumination LED is flashing in red, count how many times it flashes (interval time is three seconds).

If the illumination LED flashes red, reset the TV by disconnecting the mains lead for two minutes, then turn on the TV.

If the problem persists, contact your dealer or Sony service centre with the number of times the illumination LED flashes red (interval time is three seconds). Disconnect the mains lead, and inform your dealer or Sony service centre.

When the illumination LED is not flashing, check the items as follows.

You can also refer to troubleshooting in the Help Guide or perform self-diagnosis by selecting [Help] → [Self diagnostics]. If the problem persists, have your TV serviced by qualified service personnel.

Troubles and Solutions

There is no picture (screen is dark) and no sound.

- Check the antenna (aerial)/cable connection.
- Connect the TV to mains lead, and press \odot on the TV or the remote control.

Some programmes cannot be tuned.

- Check the antenna (aerial)/cable connection.
- The satellite cable might be short-circuited or there might be connection problems with the cable. Check the cable connection and then turn the TV off with the Mains power On/Off switch, and turn it on again.
- The frequency that you entered is out of range. Consult the received satellite broadcasting company.

There is no Cable TV services (programmes) found.

- Check the cable connection or tuning configuration.
- Attempt the [Digital Auto Tuning] by selecting [Antenna] instead of [Cable].

The remote control does not function.

- Replace the batteries.

The [Parental lock (Broadcast)] password has been forgotten.

- Enter 9999 for the PIN code. Update PIN code by selecting [Settings] → [Parental lock (Broadcast)] → [Change PIN code].

The TV surrounds become warm.

- When the TV is used for an extended period, the TV surrounds become warm.
You may feel hot when touching there by the hand.

Frozen audio or video, a blank screen, or the TV does not respond to TV or remote control buttons.

- Perform a simple reset of the TV by unplugging the mains lead for two minutes, then plug it in again.

The , **+**, and **-** buttons cannot be located on the TV.

- See below illustration for location of the buttons on the TV.

Rear of TV

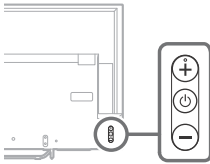

The illumination LED is turned on.

- If you do not wish to light up the illumination LED, you can turn it off.
Press **HOME**, then select [Settings] → [Illumination LED] → [Off].

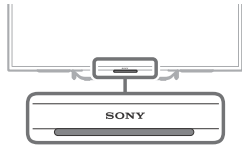

Cannot connect to a wireless router by WPS (Wi-Fi Protected Setup).

- If you use WEP security, select [Easy] → [Wi-Fi] → [Connect by scan list]. Then, select the network name (SSID) you want to connect.

Cannot find the required network name in network setup.

- Select [[Manual entry]] and press  to enter network name.

Specifications

System

Panel system

LCD (Liquid Crystal Display) Panel, LED Backlight

TV system

Depending on your country/area selection/TV model

Analogue: B/G, D/K, L, I

Digital: DVB-T/DVB-C

DVB-T2*

Satellite*: DVB-S/DVB-S2

Colour/video system

Analogue: PAL, SECAM, NTSC3.58 (Video only),

NTSC4.43 (Video only)

Digital: Refer to the Help Guide.

Channel coverage

Depending on your country/area selection/TV model

Analogue: UHF/VHF/Cable

Digital: UHF/VHF/Cable

Satellite*: IF Frequency 950-2,150 MHz

Sound output

10 W + 10 W

Wireless technology

Protocol IEEE802.11ac/a/b/g/n

Bluetooth Version 4.1

- * Not all the TV sets have DVB-T2 or DVB-S/S2 technology or satellite antenna terminal.

Input/Output jacks

Antenna (aerial)/cable

75 ohm external terminal for VHF/UHF

Satellite antenna

Female F-Type Connector, 75 ohm.

DiSEqC 1.0, LNB 13 V/18 V & 22 kHz tone, Single Cable Distribution EN50494.

 AV 1

21-pin scart connector (CENELEC standard) including audio/video input, RGB input and TV audio/video output.

 AV 2

Video/Audio input (mini jack)

HDMI IN 1, 2, 3, 4 (Support 4K resolution, HDCP 2.2-compatible)

Video:

4096 × 2160p (50, 60 Hz)*¹, *², 4096 × 2160p (24 Hz)*¹, 3840 × 2160p (50, 60 Hz)*², 3840 × 2160p (24, 25, 30 Hz), 1080p (30, 50, 60 Hz), 1080/24p, 1080i (50, 60 Hz), 720p (30, 50, 60 Hz), 720/24p, 576p, 576i, 480p, 480i, PC Formats

*¹ 3840 × 2160p is displayed when 4096 × 2160p is input

*² HDMI IN 2 / 3 only.

Audio: 5.1 channel linear PCM: 32, 44.1, 48, 88.2, 96, 176.4 and 192 kHz, 16, 20 and 24 bits, Dolby Digital, Dolby Digital Plus and DTS ARC (Audio Return Channel) (HDMI IN 3 only) (Two channel linear PCM, Dolby Digital, Dolby Digital Plus, DTS)

⊖ DIGITAL AUDIO OUT (OPTICAL)

Digital optical jack (Two channel linear PCM, Dolby Digital, DTS)

AUDIO OUT ⊖ / ⊕ (Stereo mini jack)

Headphone, Audio output, Subwoofer

• ← 1, • ← 2, **SS** ← 3 (HDD REC)*¹

USB device port (**SS** ← 3 USB HDD device for REC feature)

USB port 1 and 2 support High Speed USB (USB2.0).

USB port 3 supports Super Speed USB (USB3.0).



CAM (Conditional Access Module) slot



LAN

10BASE-T/100BASE-TX connector (Depending on the operating environment of the network, connection speed may differ. 10BASE-T/100BASE-TX communication rate and communication quality are not guaranteed for this TV.)

Others

Optional accessories

Wall-Mount Bracket: SU-WL450

Voice Remote Control: RMF-TX200E

Wireless Subwoofer: SWF-BR100

Условия хранения:

Товары сохраняют в упакованном виде в темных, сухих, чистых, хорошо вентилируемых помещениях, изолированных от мест хранения кислот и щелочей.

Температура хранения*: от -20 °C до +60 °C. Относительная влажность хранения*: < 80 % (без конденсации).

* Примечание: максимальные значения для обоих параметров не могут быть достигнуты одновременно.

Рабочая температура: от 0 °C до 40 °C. Рабочая относительная влажность: 10 % - 80 % (без конденсации).

Умови зберігання:

Продукцію зберігають в упакованому виді в темних, сухих, чистих, добре вентильованих приміщеннях, ізолюваних від місць зберігання кислот і лугів. Температура зберігання*: від -20 °C до +60 °C. Відносна вологість зберігання*: < 80 % (без конденсації).

* Примітка: неможливо отримати максимальні значення для обох параметрів одночасно.

Робоча температура: від 0 °C до 40 °C. Робоча відносна вологість: 10 % - 80 % (без конденсації).

Сақтау шарты:

Өнімдерді қараңғы, құрғақ, таза, жақсы желдетілетін қышқылдар мен сілтілік металдар сақталған орыннан оқшауланған бумада сақтау қажет. Сақтау температурасы*: -20 °C мен +60 °C аралығы. Сақтау ылғалдылығы*: < 80% салыст. ылғалдылық (конденсациясыз).

* Ескерту: Екі параметрдің ең үлкен мәндеріне бір уақытта жету мүмкін емес.

Жұмыс температурасы

0 °C мен 40 °C аралығы

Жұмыс ылғалдылығы

10 % - 80 % салыст. ылғалдылық (конденсациясыз)

Power, Product Fiche and others

Power requirements

Rating: Input 220 V - 240 V AC, 50 Hz

Energy Efficiency Class

KD-65XD7505: A

KD-55XD7005: A

KD-49XD7005: A

Screen size (measured diagonally) (Approx.)

KD-65XD7505: 163.9 cm / 65 inches

KD-55XD7005: 138.8 cm / 55 inches

KD-49XD7005: 123.2 cm / 49 inches

Удельная потребляемая мощность в режиме

[Стандартный]:

KD-65XD7505: 10,9 мВт/см²

KD-55XD7005: 13,7 мВт/см²

KD-49XD7005: 13,9 мВт/см²

Power consumption

in [Standard] mode

KD-65XD7505: 125 W

KD-55XD7005: 112 W

KD-49XD7005: 90 W

in [Vivid] mode

KD-65XD7505: 206 W

KD-55XD7005: 184 W

KD-49XD7005: 151 W

Average annual energy consumption*²

KD-65XD7505: 173 kWh

KD-55XD7005: 155 kWh

KD-49XD7005: 125 kWh

Standby power consumption*^{3,4}

0.50 W (14 W in software/EPG update mode)

Display resolution

3,840 dots (horizontal) × 2,160 lines (vertical)

Output Rating

USB 1/2: 5 V, $\overline{=}$, 500 mA MAX

USB 3: 5 V, $\overline{=}$, 900 mA MAX

Dimensions (Approx.) (w × h × d)

with Table-Top Stand

KD-65XD7505: 146.3 × 90.1 × 29.5 cm

KD-55XD7005: 124.5 × 77.0 × 23.5 cm

KD-49XD7005: 110.7 × 69.0 × 23.5 cm

without Table-Top Stand

KD-65XD7505: 146.3 × 85.2 × 8.0 cm

KD-55XD7005: 124.5 × 73.0 × 7.8 cm

KD-49XD7005: 110.7 × 65.1 × 7.8 cm

Mass (Approx.)

with Table-Top Stand

KD-65XD7505: 22.7 kg

KD-55XD7005: 17.8 kg

KD-49XD7005: 14.1 kg

without Table-Top Stand

KD-65XD7505: 21.5 kg

KD-55XD7005: 16.9 kg

KD-49XD7005: 13.2 kg

*¹ Only on limited region/country/TV model.

*² Energy consumption per year, based on the power consumption of the television operating 4 hours per day for 365 days. The actual energy consumption will depend on how the television is used.

*³ Specified standby power is reached after the TV finishes necessary internal processes.

*⁴ Standby power consumption will increase when your TV is connected to the network.

Note

- Do not remove the dummy card from TV CAM (Conditional Access Module) slot other than to insert a smart card fitted in CAM.
- Optional accessories availability depends on countries/region/TV model/stock.
- Design and specifications are subject to change without notice.

Notes on Digital TV function

- Any functions related to Digital TV (DVB) will only work in countries or areas where DVB-T/DVB-T2 (MPEG-2 and H.264/MPEG-4 AVC) digital terrestrial signals are broadcast or where you have access to a compatible DVB-C (MPEG-2 and H.264/MPEG-4 AVC) cable service. Please confirm with your local dealer if you can receive a DVB-T/DVB-T2 signal where you live or ask your cable provider if their DVB-C cable service is suitable for integrated operation with this TV.
- Your cable provider may charge a fee for their services, or require you to agree to its terms and conditions of business.
- This TV set complies with DVB-T/DVB-T2 and DVB-C specifications, but compatibility with future DVB-T/DVB-T2 digital terrestrial and DVB-C digital cable broadcasts are not guaranteed.
- Some Digital TV functions may not be available in some countries/areas and DVB-C cable may not operate correctly with some providers.

Trademark Information

- The terms HDMI and HDMI High-Definition Multimedia Interface, and the HDMI Logo are trademarks or registered trademarks of HDMI Licensing LLC in the United States and other countries.
- Manufactured under license from Dolby Laboratories. Dolby, Dolby Audio, and the double-D symbol are trademarks of Dolby Laboratories.
- “BRAVIA” and BRAVIA are trademarks of Sony Corporation.
- Gracenote, Gracenote eyeQ, Gracenote VideoID, Gracenote Video Explore, the Gracenote logo and logotype, and the “Powered by Gracenote” logo are either registered trademarks or trademarks of Gracenote in the United States and/or other countries.
- Opera® Devices SDK from Opera Software ASA. Copyright 1995-2015 Opera Software ASA. All rights reserved.
- Wi-Fi, Wi-Fi Direct, Miracast, Wi-Fi Protected Setup and Wi-Fi CERTIFIED Logo are trademarks or registered trademarks of Wi-Fi Alliance.
- For DTS patents, see <http://patents.dts.com>. Manufactured under license from DTS, Inc. DTS, the Symbol, & DTS and the Symbol together are registered trademarks, and DTS Digital Surround is a trademark of DTS, Inc. © DTS, Inc. All Rights Reserved.
- QuickSet and the QuickSet logo are trademarks of Universal Electronics Inc. Portions © UEI 2000-2015
- The Bluetooth® word mark and logos are registered trademarks owned by Bluetooth SIG, Inc. and any use of such marks by Sony Corporation is under license. Other trademarks and trade names are those of their respective owners.
- DiSEqC™ is a trademark of EUTELSAT. This TV supports DiSEqC 1.0. This TV is not intended for controlling motorized antennas.
- TUXERA is a registered trademark of Tuxera Inc. in the US and other countries.
- USB-IF SuperSpeed USB Trident logo is a registered trademark of USB Implementers Forum, Inc. 

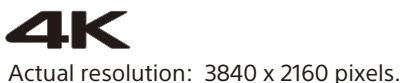

Справочное руководство
Довідка

Для получения полезной информации о продукции Sony
Для отримання корисної інформації щодо виробів компанії Sony

www.sony.eu/support

